



# AS RETRIEVABLE BRIDGE PLUG

## RIGHT-HAND SET / RELEASE

### 9-5/8" W/ 4-1/2" IF TOOL JOINT

Manual No:  
**DL-725-9625-075**

Revision: **D**

Revision Date:  
**11/21/2023**

Authored by: J.Anderson

Approved by: D.Hushbeck

#### A) DESCRIPTION

The AS Retrievable Bridge Plug is a high pressure plug for multiple zone and selective single zone operations such as acidizing, fracturing, cementing, and testing. It features a large internal by-pass to reduce swabbing when running and retrieving. The by-pass closes during the setting of the plug and opens prior to releasing the upper slips to equalize pressure when unsetting. The by-pass is located directly below the upper slips to help wash debris when the by-pass is open.

This tool can be set in tension and compression. It can be set shallow in unsupported casing to contain pressure while working on wellhead equipment. It can be set in tension making it ideal for setting shallow to test wellhead equipment and also deep, high pressure wells.

The ASW Retrievable Bridge Plug is a version of the AS Retrievable Bridge Plug that allows the plug to be set on wireline or with a hydraulic setting tool, and retrieved with tubing. It cannot be reset in the wellbore once it is unset, but it can be pulled, re-dressed and run again. A Wireline Adapter Kit is required for this version.

**CAUTION<sub>1</sub>:** When running this tool with a packer, make sure the J-slots in the plug, running/ retrieving tool, and packer are all compatible.

#### B) RELATED TOOLS (sold separately)

B-1) 9-5/8" X 4-1/2" IF Tool Joint Spring Loaded Retrieving Tool (P/N 57795-XBEE) – refer to technical manual *DL-577-9625-591*.

#### C) SPECIFICATION GUIDE

CASING			TOOL OD (INCHES)	THREAD CONNECTION PIN DOWN	PART NUMBER
SIZE (INCHES)	WEIGHT (LBS/FT)	RECOMMENDED HOLE SIZE (INCHES)			
9-5/8	32.3 - 43.5	8.755 - 9.001	8.500	4-1/2 IF TOOL JOINT	72596RR-XBEE 72596RRH-XBEE <sup>1</sup> 72596RRV-XBEE <sup>2</sup>
	43.5 - 53.5	8.535 - 8.755	8.250	4-1/2 IF TOOL JOINT	72595RR-XBEE 72595RRH-XBEE <sup>1</sup> 72595RRV-XBEE <sup>2</sup>

Elastomer Trim Options: HSN<sup>1</sup>, Viton<sup>2</sup>

**NOTE<sub>1</sub>:** Tools listed are right-hand set / right-hand release. Additional J-slot designs are available.

DIFFERENTIAL PRESSURE (MAX)	HANGING WEIGHT ON SET TOOL (MAX)	TENSILE LOAD THRU TOOL (MAX)	TORQUE THRU TOOL (MAX)
8,000 PSI	106,200 LBS <sup>†</sup>	106,200 LBS	2,000 FT-LBS

<sup>†</sup>Casing must be cemented for this load rating.

D & L OIL TOOLS  
P.O. BOX 52220 TULSA, OK 74152  
PHONE: (800) 441-3504 [www.dloiltools.com](http://www.dloiltools.com)



# AS RETRIEVABLE BRIDGE PLUG

## RIGHT-HAND SET / RELEASE

### 9-5/8" W/ 4-1/2" IF TOOL JOINT

Manual No:  
**DL-725-9625-075**

Revision: **D**

Revision Date:  
**11/21/2023**

Authored by: J.Anderson

Approved by: D.Hushbeck

#### D) PRE-INSTALLATION INSPECTION PROCEDURES

**CAUTION<sub>2</sub>:** D&L ships tool connections made-up **HAND TIGHT**—labeled with hand-tight tape on the tool (Fig. 1)—unless stated otherwise. Tighten/torque all connections properly before operating tool.



Fig. 1

GENERAL THREAD CONNECTION TORQUE RECOMMENDATIONS			
STUB ACME / ACME THREADS	INTERNAL TAPERED TUBING THREADS		PREMIUM THREADS
	UP TO 2-3/8"	GREATER THAN 2-3/8"	
600 – 800 FT-LBS	600 – 800 FT-LBS	800 – 1,200 FT-LBS	Consult thread manufacturer's recommendations.

GENERAL SCREW TORQUE RECOMMENDATIONS									
SCREW SIZE (INCHES)	#6	#8	#10	1/4	5/16	3/8	7/16	1/2	5/8 and larger
TORQUE RANGE (INCH-POUNDS)	5 – 8	10 – 15	18 – 25	25 – 40	50 – 80	90 – 135	160 – 210	250 – 330	450 - 650

Before first use, D&L recommends disassembly and inspection of the tool unless stated otherwise. Ensure parts have not been damaged during shipping. Replace damaged parts with D&L replacement parts. Contact D&L sales for replacement part information.

Re-assemble the tool after inspection. Install parts in the correct order and orientation. Properly tighten connections.

Before re-using the tool, D&L recommends disassembly and inspection of the tool. Clean parts and ensure parts are in good working condition. Replace worn or damaged parts with D&L replacement parts.

When redressing the tool, D&L recommends replacement of all seals, elements, o-rings, shear screws, etc. Contact D&L sales for redress kit and/or other replacement part information.

#### E) SETTING PROCEDURES

**CAUTION<sub>3</sub>:** Do not run the tool without properly tightening connections. Running the tool with loose connections may damage the tool and cause malfunction.

**CAUTION<sub>4</sub>:** Lift the AS Retrieval Bridge Plug by placing the sling or chain just below the pulling head. **DO NOT** lift the bridge plug by the upper slip body assembly (Fig. 2).

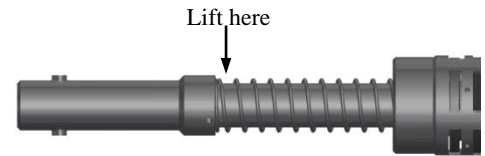

Fig. 2

##### E-1) TENSION SET

Run to setting depth while latched to its spring loaded retrieving tool. Pick up, rotate 1/4 turn to the right at the plug, and lower work string to set lower slips. Pull tension to pack-off elements, slack off, and then pick up again to assure plug setting (20,000 lbs minimum). After setting plug, slack off work string weight, hold left-hand torque and pick up to free work string from plug.

##### E-2) COMPRESSION SET

Run to setting depth while latched to its spring-loaded retrieving tool. Pick up, rotate 1/4 turn to the right at the plug, and lower work string to set lower slips. Slack off sufficient weight to pack-off elements, then pick up to firmly set upper slips and slack off again (20,000 lbs minimum). After setting plug, slack off work string weight, hold left-hand torque and pick up the free work string from plug.



# AS RETRIEVABLE BRIDGE PLUG

RIGHT-HAND SET / RELEASE  
9-5/8” W/ 4-1/2” IF TOOL JOINT

Manual No:  
**DL-725-9625-075**

Revision: **D**

Revision Date:  
**11/21/2023**

Authored by: J.Anderson

Approved by: D.Hushbeck

## F) RELEASING PROCEDURES

Lower work string until the retrieving tool automatically latches to the AS Retrievable Bridge Plug. Sand may be washed from the upper slip by circulating through the upper portion of the plug. Slack off weight, hold right-hand torque pick up to open the by-pass valve, and wait until differential pressure has equalized. Continue upward movement to release upper slips, relax packing elements and re-latch. The plug may now be removed or re-located.

### F-1) EMERGENCY RELEASE

If the plug will not release conventionally, slack off re-set, then pick straight up to shear J-pins and release the plug (standard J-pins will shear at 50,000 lbs each – refer to Parts List for J-pins with other shear values). Once the J-pins are sheared, the tool cannot be moved down hole.

**NOTE<sub>2</sub>:** Contact D&L Engineering if running tool equipped with lower than standard value shear J-pins.

## G) STORAGE RECOMMENDATIONS

When preparing the tool for storage, follow the Pre-Installation Inspection Procedures. Re-assemble the tool with connections hand-tight only and in running position if applicable. Elements should be in a relaxed state—free from tension, compression, and other stresses that could cause deformation.

Store the tool, if possible, in an enclosed, temperature and humidity controlled environment. Avoid excessively high temperatures over long periods of time. Shield elastomeric parts from ultraviolet light sources. Keep tool dry and protected from condensation. Do not store in contact with or near volatile or corrosive chemicals. Do not store near ozone generating equipment or operations such as welding.

## H) PRESSURE AFFECTED AREA GUIDE

When set downhole, the packer mandrel is subjected to a force created by differential pressure above or below the packer that acts on the pressure affected area (i.e., the piston effect). Depending on the tubing size and weight and the seal area of the packer the force created by differential pressure acts upwards or downwards on the packer mandrel. An upward force, designated as a negative (-) value, acts to push the packer mandrel up hole and must be accounted for when releasing the packer. A downward force, designated as a positive value, acts to push the packer mandrel down hole and must be accounted for when releasing the packer. Other factors (e.g., tubing movement due to temperature change) must be considered separately to determine all the forces acting on the packer.

PACKER SIZE (INCHES)	PRESSURE AFFECTED AREA (SQ. INCHES)	
	ABOVE	BELOW
9-5/8	8.296 (DOWN)	-8.296 (UP)

**Example:** Consider a 9-5/8” AS Bridge Plug set on tubing with a differential pressure of 3,000 psi in the annulus around the tubing above the packer. What is the force acting on the seal area of the mandrel?

To calculate the force (lbs) acting on the seal area of the mandrel, refer to the Pressure Affected Area Guide for a 9-5/8” AS Bridge Plug. In this example, the differential pressure from above the packer acts on the seal area of the packer mandrel across a pressure affected area of 8.296 in<sup>2</sup>. Multiplying the differential pressure (3,000 psi) by the pressure affected area (8.296 in<sup>2</sup>) results in a force of 24,887 lbs. The piston effect on the packer mandrel is a downward force of 24,887 lbs.



# AS RETRIEVABLE BRIDGE PLUG

RIGHT-HAND SET / RELEASE  
9-5/8" W/ 4-1/2" IF TOOL JOINT

Manual No:  
**DL-725-9625-075**

Revision: **D**

Revision Date:  
**11/21/2023**

Authored by: J.Anderson

Approved by: D.Hushbeck

## I) ELASTOMER TRIM TEMPERATURE GUIDE

NITRILE (STD)			
TEMPERATURE RANGE (F°)	DUROMETER		
	END	MIDDLE	END
40° - 125°	80	70	80
125° - 250°	90	70	90
150° - 250°	90	80	90
250° +	Contact D&L Sales		

RUBBER TYPE	TEMPERATURE RANGE
NITRILE	40° - 250°F
HSN (HNBR)	70° - 300°F
VITON	100° - 350°F

## J) RECOMMENDED TOOLS

### J-1) HAND TOOLS

- VISE
- GLOVES
- ALLEN WRENCHES
- TAPE MEASURE
- O-RING PICK
- BAR
  - 1/2-INCH
  - 3/4-INCH
- PAINT BRUSH, 2-INCH
- PIPE WRENCH, 4-FT (2 EA)
- "CHEATER" PIPE, 4-FT LONG
- ADJUSTABLE WRENCH, 12-INCH
- CORDLESS DRILL, 18V
- SNAP RING SPREADER PLIERS
- ALIGNING PUNCH
- SCREWDRIVER SET, FLAT-TIPPED
- SOCKET SETS
  - 3/8-INCH DRIVE
  - 1/2-INCH DRIVE
- HAMMERS
  - SLEDGE
  - BALL PEEN
  - DEAD BLOW
- JACK STANDS

### J-2) SPECIAL TOOLS

ITEM	QTY	DESCRIPTION	PART NUMBER
T1	1	DRAG BLOCK ASSEMBLY TOOL	AT095110

## K) DISASSEMBLY

**NOTE<sub>3</sub>**: Ensure vise is capable of handling weight of tool.

**NOTE<sub>4</sub>**: Support tool during disassembly and assembly with jack stands as necessary.

K-1) Clamp upper cone (9) in vise.

**NOTE<sub>5</sub>**: If needed, align hole in upper cone (9) with slot in sealing mandrel (27) and insert punch (or other tool) to prevent tool components from rotating during disassembly.

K-1.1) From lower end of tool, unscrew and remove set screws (39) from bottom sub (40).

K-1.2) Unscrew and remove bottom sub (40) from J-body (20).

K-1.2.1) Remove o-rings (44) from bottom sub (40).

K-1.3) Unscrew and remove set screws (39) from lower end of body extension (28).

K-1.4) Unscrew and separate body extension (28) from J-pin body (23) (**NOTE<sub>6</sub>**: Left-hand threads).

**NOTE<sub>7</sub>**: Drag block body assembly must be free to rotate.

K-1.5) Remove J-pins (35) from J-pin body (23).

K-1.6) Remove J-pin body (23) from J-slot mandrel (20).

K-1.7) Compress drag blocks (22) with drag block body assembly tool (T1). Unscrew and remove set screws (39) from drag block body (18). Rotate drag block retainer (21) as needed to access set screws (39).



# AS RETRIEVABLE BRIDGE PLUG

## RIGHT-HAND SET / RELEASE

### 9-5/8" W/ 4-1/2" IF TOOL JOINT

Manual No:  
**DL-725-9625-075**

Revision: **D**

Revision Date:  
**11/21/2023**

Authored by: J.Anderson

Approved by: D.Hushbeck

#### K) DISASSEMBLY (cont'd)

- K-1.8) Unscrew and remove body extension (28) from drag block body (18) (**NOTE<sub>6</sub>**: Left-hand threads).
  - K-1.8.1) Remove retaining ring (31) from body extension (28).
- K-1.9) Remove drag block retainer (21) from drag block body (18).
- K-1.10) Release drag blocks (22). Remove drag blocks (22) and drag block springs (3) from drag block body (18).
- K-1.11) Unscrew and remove rubber mandrel cap (19) from lower rubber mandrel (34).
- K-1.12) Remove drag block body assembly and disassemble:
  - K-1.12.1) Wedge lower slips (17) outward (if needed). Unscrew and remove cap screw (37) from drag block body (18).
  - K-1.12.2) Remove lower slip support (32) from drag block body (18).
  - K-1.12.3) Remove wedges (if needed). Remove lower slips (17) and lower slip springs (25) from drag block body (18).
- K-1.13) Unscrew and remove lower cone (16) from rubber retainer (15).
- K-1.14) Unscrew and remove set screws (38) from lower rubber mandrel (34).
- K-1.15) Unscrew and remove lower rubber mandrel (34) from rubber mandrel (11).
- K-1.16) Unscrew and remove set screws (38) from J-slot mandrel (20).
- K-1.17) Unscrew and remove J-slot mandrel (20) from sealing mandrel (27).
- K-1.18) Unscrew rubber mandrel (11) from center coupling (10).
- K-1.19) Remove rubber mandrel assembly and disassemble:
  - K-1.19.1) Remove elements (13, 14), rubber spacers (12), and rubber retainer (15) from secondary rubber mandrel (36).
  - K-1.19.2) Remove secondary rubber mandrel (36) from rubber mandrel (11).
  - K-1.19.3) Remove o-ring (43) from rubber mandrel (11).
- K-1.20) Unscrew and remove gage ring (29) from center coupling (10).
- K-1.21) Moving to upper end of tool, unscrew and remove set screws (38 or 39) from pulling head (1).
- K-1.22) Unscrew and remove pulling head (1) from upper mandrel (2).
  - CAUTIONS:** Compression spring (4) is compressed with spring tension against pulling head (1).
- K-1.23) Remove compression spring (4) from upper mandrel (2).
- K-1.24) Remove upper slip body assembly and disassemble:
  - K-1.24.1) Wedge releasing slips (7) and upper slips (8) outward (if needed). Unscrew and remove upper slip support (33) from upper slip body (6).
  - K-1.24.2) Remove wedges (if needed). Remove releasing slips (7), upper slips (8), and upper slip springs (26) from upper slip body (6).
- K-1.25) Unscrew and remove set screws (38) from upper mandrel (2).
- K-1.26) Unscrew and remove upper mandrel (2) from sealing mandrel (27).
- K-1.27) Remove plug (5) from sealing mandrel (27).
  - K-1.27.1) Remove o-ring (42) from plug (5).
- K-1.28) Remove sealing mandrel (27) from center coupling (10).
- K-1.29) Unscrew and remove set screws (39) from upper cone (9).
- K-1.30) Unscrew and remove center coupling (10) from upper cone (9).
  - K-1.30.1) Remove bonded seals (24) from center coupling (10).
    - K-1.30.1.1) Remove o-rings (41) from bonded seals (24).



# AS RETRIEVABLE BRIDGE PLUG

## RIGHT-HAND SET / RELEASE

### 9-5/8" W/ 4-1/2" IF TOOL JOINT

Manual No:  
DL-725-9625-075

Revision: D

Revision Date:  
11/21/2023

Authored by: J.Anderson

Approved by: D.Hushbeck

#### K) DISASSEMBLY (cont'd)

- K-1.30.2) Remove o-ring (45) from center coupling (10).
- K-2) Unclamp and remove upper cone (9) from vise.
  - K-2.1) Remove seal retaining ring (30) from upper cone (9).

#### L) ASSEMBLY

**NOTE<sub>3</sub>:** Ensure vise is capable of handling weight of tool.

**NOTE<sub>4</sub>:** Support tool during disassembly and assembly with jack stands as necessary.

**NOTE<sub>9</sub>:** Clean and inspect all parts. Replace all worn and damaged parts. Install parts in proper order, orientation and tighten/torque all connections properly.

**CAUTION<sub>6</sub>:** To ensure tool operates properly, install o-rings in o-ring grooves NOT thread reliefs (Fig. 3).

L-1) Clamp upper cone (9) in vise.

- L-1.1) Install seal retaining ring (30) in upper cone (9).
- L-1.2) Install o-ring (45) in o-ring groove in center coupling (10).
- L-1.3) Install o-rings (41) in o-ring grooves in bonded seals (24).
- L-1.4) Install bonded seals (24) in center coupling (10).

**CAUTION<sub>7</sub>:** Do not rip or tear o-rings during installation.

- L-1.5) Screw center coupling (10) into upper cone (9).
- L-1.6) Screw set screws (39) into upper cone (9).
- L-1.7) Install sealing mandrel (27) through bonded seals (24) in center coupling (10).

**CAUTION<sub>8</sub>:** Do not damage bonded seals during installation.

- L-1.8) Install o-ring (39) in o-ring groove in plug (5).
- L-1.9) Install plug (5) into end of sealing mandrel (27).

**CAUTION<sub>7</sub>:** Do not rip or tear o-ring during installation.

L-1.10) Screw upper mandrel (2) onto sealing mandrel (27).

**NOTE<sub>5</sub>:** If needed align hole in upper cone (9) with slot in sealing mandrel (27) and insert punch (or other tool) to prevent tool components from rotating during assembly.

- L-1.11) Screw set screws (38) into upper mandrel (2).
- L-1.12) Assemble upper slip body assembly and install:

L-1.12.1) Install releasing slips (7), upper slips (8) and upper slip springs (26) into upper slip body (6). Wedge slips outward.

**NOTE<sub>10</sub>:** Install two (2 ea) springs per slip (Fig. 4).

L-1.12.2) Screw upper slip support (33) into upper slip body (6). Remove wedges.

L-1.12.3) Install upper slip body assembly onto upper mandrel (2).

L-1.13) Install compression spring (4) onto upper mandrel (2).

L-1.14) Screw pulling head (1) onto upper mandrel (2).

**CAUTION<sub>5</sub>:** Compression spring (4) will be compressed with spring tension against pulling head (1).

L-1.15) Screw set screws (38 or 39) into pulling head (1).

L-1.16) Moving to lower end of tool, screw gage ring (29) onto center coupling (10).

L-1.17) Assemble rubber mandrel assembly and install:

L-1.17.1) Install o-ring (43) in o-ring groove in rubber mandrel (11)..

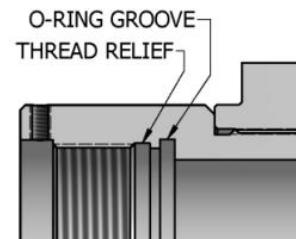

Fig. 3



Fig. 4



# AS RETRIEVABLE BRIDGE PLUG

## RIGHT-HAND SET / RELEASE

### 9-5/8" W/ 4-1/2" IF TOOL JOINT

Manual No:  
DL-725-9625-075

Revision: D

Revision Date:  
11/21/2023

Authored by: J.Anderson

Approved by: D.Hushbeck

#### L) ASSEMBLY (cont'd)

L-1.17.2) Install secondary rubber mandrel (36) onto rubber mandrel (11).

**CAUTION7:** Do not rip or tear o-ring during installation.

L-1.17.3) Install rubber retainer (15), elements (13, 14), and rubber spacers (12) onto secondary rubber mandrel (36).

L-1.17.4) Install rubber mandrel assembly onto sealing mandrel (27).

L-1.18) Screw rubber mandrel (11) into center coupling (10).

L-1.19) Screw J-slot mandrel (20) onto sealing mandrel (27).

L-1.20) Screw set screws (38) into J-slot mandrel (20).

L-1.21) Screw lower rubber mandrel (34) onto rubber mandrel (11).

L-1.22) Screw set screws (38) into lower rubber mandrel (34).

L-1.23) Screw lower cone (16) into rubber retainer (15).

L-1.24) Assemble drag block body assembly and install:

L-1.24.1) Install lower slips (17) and lower slip springs (25) into drag block body (18). Wedge slips outward.

**NOTE11:** Install two (2 ea) springs per slip (Fig. 5).

L-1.24.2) Install lower slip support (32) into drag block body (18). Align threaded hole in drag block body (18) with hole in lower slip support (32).

L-1.24.3) Screw cap screw (37) into drag block body (18). Remove wedges.

L-1.24.4) Install drag block body assembly onto lower rubber mandrel (34).

L-1.25) Screw rubber mandrel cap (19) onto lower rubber mandrel (34).

L-1.26) Install drag blocks (22) and drag block springs (3) into drag block body (18). Compress drag blocks (22) with drag block body assembly tool (T1).

**NOTE12:** Install six (6 ea) springs per drag block (Fig. 6).

L-1.27) Install drag block retainer (21) onto drag block body (18) capturing ends of drag blocks (22).

L-1.28) Install retaining ring (31) onto body extension (28).

L-1.29) Screw body extension (28) into drag block body (18) (**NOTE6:** Left-hand threads).

L-1.30) Screw set screws (39) into drag block body (18). Rotate drag block retainer (21) as needed to access threaded holes in drag block body (18). Release drag blocks (22).

L-1.31) Install J-pin body (23) onto J-slot mandrel (20).

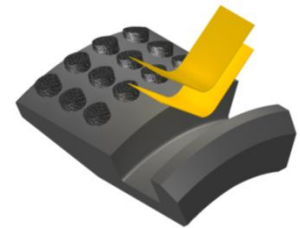

Fig. 5

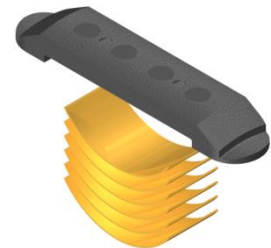

Fig. 6

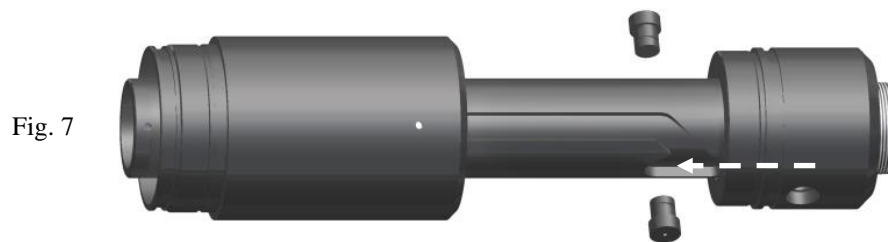

Fig. 7

L-1.32) Align holes in J-pin body (23) with running position of J-slot mandrel (20). Install J-pins (35) into J-pin body (23) (Fig. 7).

L-1.33) Slide drag block body assembly down and screw body extension (28) onto J-pin body (23) (**NOTE6:** Left-hand threads).

**NOTE7:** Drag block body assembly must be free to rotate.



# AS RETRIEVABLE BRIDGE PLUG

## RIGHT-HAND SET / RELEASE

### 9-5/8" W/ 4-1/2" IF TOOL JOINT

Manual No:  
**DL-725-9625-075**

Revision: **D**

Revision Date:  
**11/21/2023**

Authored by: J.Anderson

Approved by: D.Hushbeck

#### L) ASSEMBLY (cont'd)

L-1.34) Screw set screws (39) into body extension (28).

L-1.35) Install o-ring (44) in o-ring groove in bottom sub (40).

L-1.36) Screw bottom sub (40) on J-slot mandrel (20).

**CAUTION:** Do not rip or tear o-ring during installation.

L-1.37) Screw set screws (39) into bottom sub (40).

L-2) Unclamp upper cone (9) from vise and remove assembled tool.

#### M) PARTS LIST

ITEM	QTY	DESCRIPTION	MATERIAL	43.5 – 53.5#	
				P/N 72595RR-XBEE	P/N 72596RR-XBEE
1	1	PULLING HEAD	DLMS110	72485715	
2	1	UPPER MANDREL	DLMS110	72585210	
3	36	DRAG BLOCK SPRING	-	9101900	
4	1	COMPRESSION SPRING	DLMCRSP	60373920	
5	1	PLUG	DLMS60	72585216	
6	1	UPPER SLIP BODY	DLMS110	72495320	
7	2	RELEASING SLIP	DLMS110	61995120	
8	3	UPPER SLIP W/ CARBIDE	DLMS110	61995110C	
9	1	UPPER CONE	DLMS110	72495410	
10	1	CENTER COUPLING	DLMS110	72585620	
11	1	RUBBER MANDREL	DLMS110	72585220	
12	2	RUBBER SPACER	DLMS35	60295840S	60296840S
13	1	ELEMENT	70 DURO NITRILE	60295511S	60296511S
14	2	ELEMENT	90 DURO NITRILE	60295513S	60296513S
15	1	RUBBER RETAINER	DLMS110	60295850SHT	60296850SHT
16	1	LOWER CONE	DLMS110	60395420SHT	
17	4	LOWER SLIP W/ CARBIDE	DLMS110	60095135C	
18	1	DRAG BLOCK BODY	DLMS110	60395335HT	
19	1	RUBBER MANDREL CAP	DLMS60	72485230	
20	1	J-BODY	DLMS110	72595230-XAB	
21	1	DRAG BLOCK RETAINER	DLMS60	60395910	
22	6	DRAG BLOCK W/ CARBIDE	DLMSDB4	9080900C	
23	1	J-PIN BODY	DLMS110	72585875	
24	2	BONDED SEAL	90 DURO NITRILE	60070520	
25	8	LOWER SLIP SPRING	-	7170901	
26	10	UPPER SLIP SPRING	DLMINC625	DL94830	





# AS RETRIEVABLE BRIDGE PLUG

## RIGHT-HAND SET / RELEASE

### 9-5/8" W/ 4-1/2" IF TOOL JOINT

Manual No:  
**DL-725-9625-075**

Revision: **D**

Revision Date:  
**11/21/2023**

Authored by: J.Anderson

Approved by: D.Hushbeck

#### M) PARTS LIST (cont'd)

ITEM	QTY	DESCRIPTION	MATERIAL	43.5 – 53.5#	32.3 – 43.5#
				P/N 72595RR-XBEE	P/N 72596RR-XBEE
27	1	SEALING MANDREL	DLMS110	72595214	
28	1	BODY EXTENSION	DLMS110	72495370	
29	1	GAGE RING	DLMS110	60295830HT	60296830HT
30	1	SEAL RETAINING RING	DLMS35	72585225	
31	1	RETAINING RING	DLMS110	60095911HT	
32	1	LOWER SLIP SUPPORT	DLMS110	60395912HT	
33	1	UPPER SLIP SUPPORT	DLMS110	72495348	
34	1	LOWER RUBBER MANDREL	DLMS110	72595221	
35	2	J-PIN <b>NOTE<sub>13</sub></b> : Shear value is stamped on J-pin.	DLMS110	72585870-15 (15,000#)	
				72585870-25 (25,000#)	
				72585870 (50,000# STD)	
36	1	SECONDARY RUBBER MANDREL	DLMS110	60095221HT	
37	1	CAP SCREW 1/2-13 UNC X 3/4	STEEL	SCS050C075	
38	12	SET SCREW 3/8-16 UNC X 3/8	STEEL	SSS037C037	
				12 QTY	9 QTY
39	13	SET SCREW 3/8-16 UNC X 1/2	STEEL	SSS037C050	
				13 QTY	16 QTY
40	1	BOTTOM SUB	DLMS110	72595630-YBEE	
41	2	153 O-RING	90 DURO NITRILE	90153	
42	1	228 O-RING	90 DURO NITRILE	90228	
43	1	254 O-RING	90 DURO NITRILE	90254	
44	1	342 O-RING	90 DURO NITRILE	90342	
45	1	355 O-RING	90 DURO NITRILE	90355	

REDRESS KIT (RDK)		72595050-XBEE	72596050-XBEE
ASSEMBLED WEIGHT		744 LBS	758 LBS



**AS RETRIEVABLE BRIDGE PLUG**  
**RIGHT-HAND SET / RELEASE**  
**9-5/8" W/ 4-1/2" IF TOOL JOINT**

Manual No:  
**DL-725-9625-075**

Revision: **D**

Revision Date:  
**11/21/2023**

*Authored by: J.Anderson*

*Approved by: D.Hushbeck*

**M) PARTS LIST (cont'd)**

**M-1) ELASTOMER TRIM OPTIONS**

**NOTE<sub>14</sub>**: For temperature range, refer to Elastomer Trim Temperature Guide.

**M-1.1) HSN**

ITEM	QTY	DESCRIPTION	MATERIAL	43.5 – 53.5#	32.3 – 43.5#
				P/N 72595RRH-XBEE	P/N 72596RRH-XBEE
13	1	ELEMENT	70 DURO HSN	60295511SH	60296511SH
14	2	ELEMENT	90 DURO HSN	60295513SH	60296513SH
41	2	153 O-RING	90 DURO HSN	90153H	
42	1	228 O-RING	90 DURO HSN	90228H	
43	1	254 O-RING	90 DURO HSN	90254H	
44	1	342 O-RING	90 DURO HSN	90342H	
45	1	355 O-RING	90 DURO HSN	90355H	

REDRESS KIT (RDK)		72595050H-XBEE	72596050H-XBEE
-------------------	--	----------------	----------------

**M-1.2) VITON**

ITEM	QTY	DESCRIPTION	MATERIAL	43.5 – 53.5#	32.3 – 43.5#
				P/N 72595RRV-XBEE	P/N 72596RRV-XBEE
13	1	ELEMENT	70 DURO VITON	60295511SV	60296511SV
14	2	ELEMENT	90 DURO VITON	60295513SV	60296513SV
41	2	153 O-RING	90 DURO VITON	90153V	
42	1	228 O-RING	90 DURO VITON	90228V	
43	1	254 O-RING	90 DURO VITON	90254V	
44	1	342 O-RING	90 DURO VITON	90342V	
45	1	355 O-RING	90 DURO VITON	90355V	

REDRESS KIT (RDK)		72595050V-XBEE	72596050V-XBEE
-------------------	--	----------------	----------------



# AS RETRIEVABLE BRIDGE PLUG

RIGHT-HAND SET / RELEASE  
9-5/8" W/ 4-1/2" IF TOOL JOINT

Manual No:  
DL-725-9625-075

Revision: **D**

Revision Date:  
**11/21/2023**

Authored by: J.Anderson

Approved by: D.Hushbeck

## N) TECHNICAL ILLUSTRATION

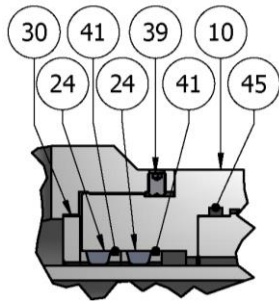

DETAIL A

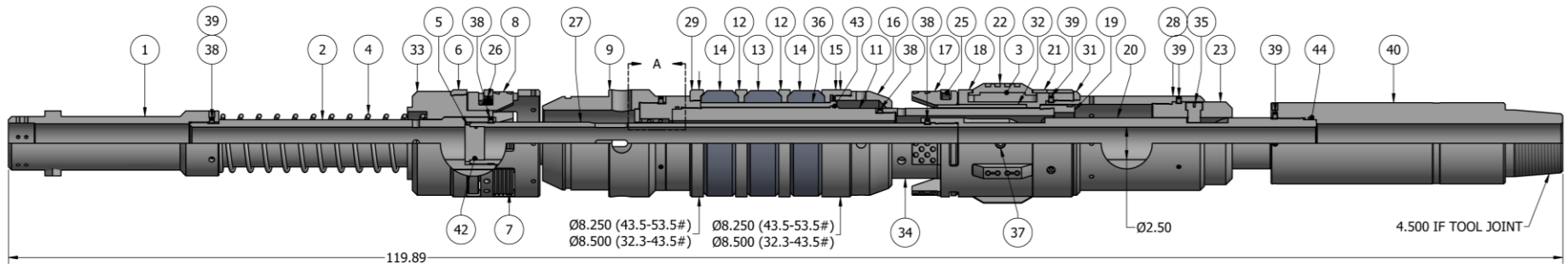

	<b>AS RETRIEVABLE BRIDGE PLUG</b> RIGHT-HAND SET / RELEASE 9-5/8” W/ 4-1/2” IF TOOL JOINT	Manual No: <b>DL-725-9625-075</b>
		Revision: <b>D</b>
		Revision Date: <b>11/21/2023</b>
<i>Authored by: J.Anderson</i>		<i>Approved by: D.Hushbeck</i>

**O) REVISION HISTORY**

DATE	REVISION	DESCRIPTION OF CHANGES	REVISED BY	APPROVED BY
11/21/2023	D	Corrected element P/Ns for P/N 72596RR-XBEE	J.Anderson	D.Mckeon
11/21/2017	C	Revised Elastomer Trim Temp. Guide nitrile temp. rating, P/N 72485715 was 72585715, 72495320 was 72595320, 72495410 was 72595410, 72495370 was 72595370, 72495348 was 72595348, P/N DL94830 qty was 5	J.Anderson	N.Banker
08/04/2016	B	Revised max. hanging weight and tensile load	J.Anderson	K.Riggs
06/01/2016	A	Created new manual	-	-