



VSI-X HT PACKER

w/ HSN ECNER

5-1/2" X 2-7/8"

Manual No:
DL-603-5500-630

Revision: **F**

Revision Date:
08/16/2019

Authored by: J.Anderson

Approved by: B.Oligschlaeger

A) DESCRIPTION

The VSI-X HT Packer, a Single-String Double-Grip Production Packer, is one of the most versatile packers on the market. This packer is a modification of the ASI-X Packer with the advantage of being able to set on electric line or hydraulically.

An On-Off Tool Stinger with a Wireline Plug installed can be attached to the top of this packer. This packer can then be lubricated in the hole and set under pressure. Once set, casing pressure can be bled off, and the tubing with an On-Off Tool Overshot can be run and latched onto the packer. The Wireline Plug can then be removed.

The VSI-X HT Packer is designed for differential pressures up to 10,000 PSI (unless noted otherwise). The HT version allows this packer to be utilized in completions where high pressure treating operations are performed and it is desirable to leave the tool in the well for production.

This packer easily converts to a mechanically set ASI-X HT Packer. To convert, remove the shear screws and install drag blocks and drag block springs. The ASI-X HT Packer sets with 1/4 right-hand rotation, and releases with 1/4 right-hand rotation. The ASI-X HT Packer can be left in tension, compression or neutral.

NOTE₁: This packer requires at least a 30 second burn on the wireline setting tool to ensure a proper set. A burn time less than 30 seconds may shear the setting tool from the packer before fully setting the packer.

B) RELATED TOOLS (sold separately)

B-1) 5-1/2" X 2-7/8" Wireline Adapter Kit (WLAK) (P/N 97151) —refer to technical manual *DL-971-5500-631*

B-2) 2-7/8" DT-2 On/Off Tool—refer to technical manual *DL-512-2875-146*.

B-3) 2-7/8" Stinger - actual P/N varies depending on customer requirements.

C) SPECIFICATION GUIDE

CASING			TOOL		THREAD CONNECTION BOX UP / PIN DOWN	PART NUMBER
SIZE (INCHES)	WEIGHT (LBS/FT)	RECOMMENDED HOLE SIZE (INCHES)	GAGE OD (INCHES)	NOMINAL ID (INCHES)		
5-1/2	14.0 – 20.0	4.778 – 5.012	4.625	2.38	2-7/8 EUE	60156HTBHC
	20.0 – 23.0	4.670 – 4.778	4.500	2.38	2-7/8 EUE	60159HTBHC
	23.0 – 26.0	4.548 – 4.670	4.406	2.38	2-7/8 EUE	60151HTBHC

NOTE₂: Tools listed are right-hand set / right-hand release.

NOTE₃: Use of a Double Hook J-slot Packer is recommended when running with a pumpjack to help prevent the packer from unsetting during well production.

DIFFERENTIAL PRESSURE (MAX)	TENSILE LOAD THRU TOOL (MAX)
10,000 PSI	86,500 LBS

D & L OIL TOOLS
P.O. BOX 52220 TULSA, OK 74152
PHONE: (800) 441-3504 www.dloiltools.com



VSI-X HT PACKER w/ HSN ECNER 5-1/2" X 2-7/8"

Manual No:
DL-603-5500-630

Revision: **F**

Revision Date:
08/16/2019

Authored by: J.Anderson

Approved by: B.Oligschlaeger

D) PRE-INSTALLATION INSPECTION PROCEDURES

CAUTION₁: D&L ships tool connections made-up **HAND TIGHT**—labeled with hand-tight tape on the tool (Fig. 1) — unless stated otherwise. Tighten/torque all connections properly before operating tool.



Fig. 1

GENERAL THREAD CONNECTION TORQUE RECOMMENDATIONS			
STUB ACME / ACME THREADS	INTERNAL TAPERED TUBING THREADS		PREMIUM THREADS
	UP TO 2-3/8"	GREATER THAN 2-3/8"	
600 – 800 FT-LBS	600 – 800 FT-LBS	800 – 1,200 FT-LBS	Consult thread manufacturer's recommendations.

GENERAL SCREW TORQUE RECOMMENDATIONS									
SCREW SIZE (INCHES)	#6	#8	#10	1/4	5/16	3/8	7/16	1/2	5/8 and larger
TORQUE RANGE (INCH-POUNDS)	5 – 8	10 – 15	18 – 25	25 – 40	50 – 80	90 – 135	160 – 210	250 – 330	450 - 650

Before first use, D&L recommends disassembly and inspection of the tools unless stated otherwise. Ensure parts have not been damaged during shipping. Replace damaged parts with D&L replacement parts. Contact D&L sales for replacement part information.

Re-assemble the tool after inspection. Install parts in the correct order and orientation. Properly tighten connections.

Before re-using the tool, D&L recommends disassembly and inspection of the tool. Clean parts and ensure parts are in good working condition. Replace worn or damaged parts with D&L replacement parts.

When redressing the tool, D&L recommends replacement of all seals, elements, o-rings, shear screws, etc. Contact D&L sales for redress kit and/or other part information.

CAUTION₂: Do not run the tool without properly tightening connections. Running the tool with loose connections may damage the tool and cause malfunction.

E) RELEASING PROCEDURES

CAUTION₇: Packers with ECNER packing elements are single-use tools and must be redressed following initial set.

The releasing procedures are the same whether the packer has been tension or compression set. Set down weight on the packer to unseat the J-pin from the tension shoulder of the J-slot. Refer to the Pressure Affected Area Guide to determine necessary set down weight on the packer. Rotate the work string 1/4 right-hand turn at the packer and pick up while holding right-hand torque. Weight in addition to pipe weight may be required to pick up on packer – refer to Pressure Affected Area Guide. The internal by-pass will open, allowing pressure to equalize. After pressure is equalized, continue to pick up to release the upper slips, relax the elements and release the lower slips thus allowing the packer to be removed from the well.

CAUTION₃: High differential pressure below the VSI-X HT Packer may cause the upper slips to wedge in tighter, requiring an extra amount of tension to release the upper slips.



VSI-X HT PACKER

w/ HSN ECNER

5-1/2" X 2-7/8"

Manual No:
DL-603-5500-630

Revision: **F**

Revision Date:
08/16/2019

Authored by: J.Anderson

Approved by: B.Oligschlaeger

F) STORAGE RECOMMENDATIONS

When preparing the tool for storage, follow the Pre-Installation Inspection Procedures. Re-assemble the tool with connections hand-tight only and in running position if applicable. Elements should be in a relaxed state—free from tension, compression, and other stresses that could cause deformation.

Store the tool, if possible, in an enclosed, temperature and humidity controlled environment. Avoid excessively high temperatures over long periods of time. Shield elastomeric parts from ultraviolet light sources. Keep tool dry and protected from condensation. Do not store in contact with or near volatile or corrosive chemicals. Do not store near ozone generating equipment or operations such as welding.

G) PRESSURE AFFECTED AREA GUIDE

When set downhole, the packer mandrel is subjected to a force created by differential pressure above or below the packer that acts on the pressure affected area (i.e., the piston effect). Depending on the tubing size and weight and the seal area of the packer the force created by differential pressure acts upwards or downwards on the packer mandrel. An upward force, designated as a negative (-) value, acts to push the packer mandrel up hole and must be accounted for when releasing the packer. A downward force, designated as a positive value, acts to push the packer mandrel down hole and must be accounted for when releasing the packer. Other factors (e.g., tubing movement due to temperature change) must be considered separately to determine all the forces acting on the packer.

PACKER SIZE (INCHES)	TUBING SIZE (INCHES)	PRESSURE AFFECTED AREA (SQ. INCHES)	
		ABOVE	BELOW
5-1/2"	2.375	2.06 (DOWN)	-3.37 (UP)
	2.875	0.00	-1.81 (UP)

Example: Consider a 5-1/2" VSI-X HT Packer set on 2.375" tubing with a differential pressure of 3,000 PSI in the annulus around the tubing above the packer. What is the force acting on the seal area of the mandrel?

To calculate the force (lbs) acting on the seal area of the mandrel, refer to the Pressure Affected Area Guide for a 5-1/2" VSI-X HT Packer run on 2.375" tubing. In this example, the differential pressure from above the packer acts on the seal area of the packer mandrel across a pressure affected area of 2.06 in². Multiplying the differential pressure (3,000 PSI) by the pressure affected area (2.06 in²) results in a force of 6,180 lbs. The piston effect on the packer mandrel is an upward force of 6,180 lbs.

H) ELASTOMER TRIM TEMPERATURE GUIDE

NITRILE (STD)			
TEMPERATURE RANGE (F°)	DUROMETER		
	END	MIDDLE	END
40° - 125°	80	70	80
125° - 250°	90	70	90
150° - 250°	90	80	90
250° +	Contact D&L Sales		

RUBBER TYPE	TEMPERATURE RANGE
NITRILE	40° - 250°F
HSN (HNBR)	70° - 300°F
VITON	100° - 350°F



VSI-X HT PACKER

w/ HSN ECNER

5-1/2" X 2-7/8"

Manual No:
DL-603-5500-630

Revision: **F**

Revision Date:
08/16/2019

Authored by: J.Anderson

Approved by: B.Oligschlaeger

I) RECOMMENDED TOOLS

I-1) HAND TOOLS

- VISE
- GLOVES
- ALLEN WRENCHES
- TAPE MEASURE
- O-RING PICK
- BAR
 - 1/2-INCH
 - 3/4-INCH
- PAINT BRUSH, 2-INCH
- PIPE WRENCH, 3-FT (2 EA)
- "CHEATER" PIPE, 4-FT LONG
- ADJUSTABLE WRENCH, 12-INCH
- CORDLESS DRILL, 18V
- SNAP RING SPREADER PLIERS
- ALIGNING PUNCH
- SCREWDRIVER SET, FLAT-TIPPED
- SOCKET SETS
 - 3/8-INCH DRIVE
 - 1/2-INCH DRIVE
- HAMMERS
 - SLEDGE
 - BALL PEEN
 - DEAD BLOW

I-2) SPECIAL TOOLS

ITEM	QTY	DESCRIPTION	PART NUMBER
T1	1	ASSEMBLY TOOL FOR 4-1/2" - 7-5/8" VSI-XW PACKER	AT100

J) DISASSEMBLY

J-1) Clamp spring cage (5) in vise.

J-1.1) Unscrew and remove shear screws (3) from J-body (20).

J-1.2) Unscrew and remove bottom nipple (22) from J-pin bottom sub (23).

J-1.3) Unscrew and remove set screws (28) from J-pin bottom sub (23). Move J-body (20) as needed.

J-1.4) Unscrew and remove J-pin bottom sub (23) from inner mandrel (2).

NOTE₄: Drag block body assembly must be free to rotate.

J-1.4.1) Remove o-ring (32) from J-pin bottom sub (23).

J-1.5) Unscrew and remove set screws (31) from J-body (20).

J-1.6) Unscrew and remove J-body (20) from drag block body (18) (**NOTE₅:** Left-hand threads).

J-1.7) Remove drag block retainer (21) from drag block body (18).

J-1.8) Unscrew and remove rubber mandrel cap (19) from rubber mandrel (11).

NOTE₆: For added leverage, insert a rod through rubber retainer (15) and rubber mandrel (11) as needed.

J-1.9) Wedge lower slips (17) outward (if needed). Remove drag block body assembly and disassemble:

J-1.9.1) Remove wedges (if needed) and remove lower slips (17) and lower slip springs (25) from drag block body (18).

J-1.10) Unscrew and remove lower cone (16) from rubber retainer (15).

J-1.11) Unscrew rubber mandrel (11) from center coupling (10).

NOTE₇: For added leverage, insert a rod through rubber retainer (15) and rubber mandrel (11) as needed.

J-1.12) Remove rubber mandrel assembly and disassemble:

J-1.12.1) Remove gage ring (29) (if applicable), element array (13), and rubber retainer (15) from rubber mandrel (11).

J-1.13) Unscrew and remove center coupling (10) from upper cone (9).

J-1.13.1) Remove dual pack seal (24) and o-ring (33) from center coupling (10).

J-1.14) Remove bearing bushing (30) and upper cone (9) from inner mandrel (2)

J-1.15) Wedge slips outwards (if needed). Unscrew and remove inner mandrel (2) from top sub (1).

J-1.16) Remove wedges (if needed) and remove releasing slip (7), upper slips (8) and upper slip springs (26) from spring cage body (5).



VSI-X HT PACKER w/ HSN ECNER 5-1/2" X 2-7/8"

Manual No:
DL-603-5500-630

Revision: **F**

Revision Date:
08/16/2019

Authored by: J.Anderson

Approved by: B.Oligschlaeger

J) DISASSEMBLY (cont'd)

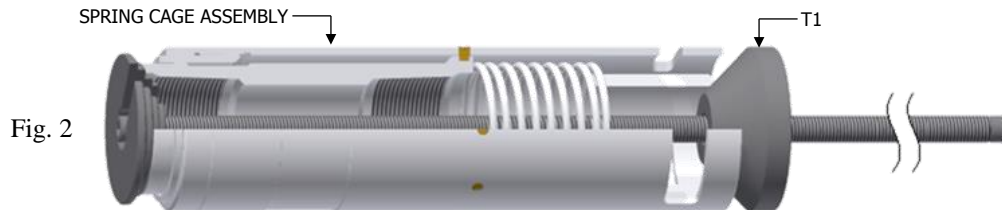

J-1.17) Disassemble spring cage assembly:

J-1.17.1) Position assembly tool (T1) hand-tight against top sub (1) and spring cage (5) of spring cage assembly (Fig. 2).

CAUTION: Compression spring (4) is compressed with tension against spring cage assembly.

J-1.17.2) Unscrew and remove shear screws (3 or 6) from spring cage (5).

J-1.17.3) Release compression spring (4) tension by loosening assembly tool (T1) until enough space exists between stepped cone of assembly tool (T1) and spring cage cap (27) for spring cage cap (27) to be unscrewed from spring cage (5).

J-1.17.4) Unscrew spring cage cap (27) from spring cage (5).

J-1.17.5) Release remaining compression spring (4) tension by loosening assembly tool (T1). Remove assembly tool (T1) from spring cage assembly.

J-1.17.6) Remove spring cage cap (27), top sub (1), and compression spring (4) from spring cage (5).

J-2) Unclamp and remove spring cage (5) from vise.

K) ASSEMBLY

NOTES: Clean and inspect all parts. Replace all worn and damaged parts. Install parts in proper order, and orientation and tighten/torque all connections properly.

CAUTION: To ensure tool operates properly, install o-rings in o-ring grooves **NOT** thread relief (Fig. 3).

K-1) Clamp spring cage (5) in vise.

K-1.1) Assemble spring cage assembly:

K-1.1.1) Install compression spring (4) and top sub (1) into spring cage (5).

K-1.1.2) Screw spring cage cap (27) into spring cage (5).

NOTE: Press down top sub (1) to compress compression spring (4) as necessary.

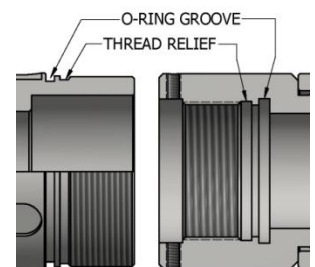

Fig. 3

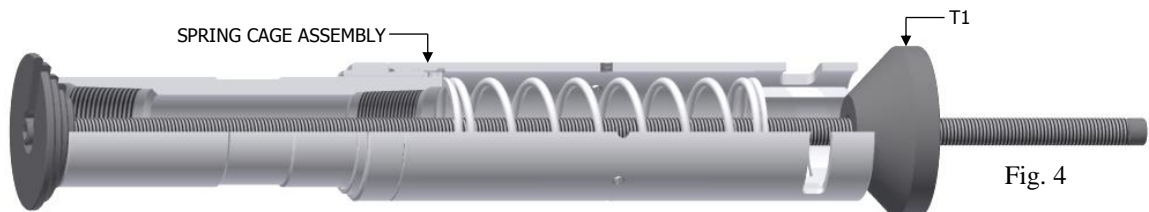

Fig. 4

K-1.1.3) Compress compression spring (4) with assembly tool (T1) (Fig. 4) to align threaded holes in spring cage (5) with recessed holes in top sub (1). Screw shear screws (3 or 6) into spring cage (5). Tighten until shear screws (3 or 6) make contact with top sub (1). Back shear screws (3 or 6) out 1/4 turn.

K-1.1.4) Remove assembly tool (T1) from spring cage assembly.

CAUTION: Compression spring (4) is compressed with tension against spring cage assembly.



VSI-X HT PACKER w/ HSN ECNER 5-1/2" X 2-7/8"

Manual No:
DL-603-5500-630

Revision: **F**

Revision Date:
08/16/2019

Authored by: J.Anderson

Approved by: B.Oligschlaeger

K) ASSEMBLY (cont'd)

K-1.1.5) Install upper slips (8), releasing slip (7) and upper slip springs (26) into spring cage (5). Wedge releasing slip (7) and upper slips (8) outwards.

NOTE10: Install two (2ea) springs per slip (Fig. 5).

K-1.2) Screw inner mandrel (2) into top sub (1). Remove wedges.

K-1.3) Install upper cone (9) and bearing bushing (30) onto lower end of inner mandrel (2).

NOTE11: Bearing bushing must be facing proper direction (see Technical Illustration - Detail A).

K-1.4) Install dual pack seal (24) into center coupling (10).

K-1.5) Install o-ring (33) in o-ring groove in center coupling (10).

K-1.6) Loosely screw center coupling (10) onto upper cone (9). Leave connection loose until the tool is pinned.

K-1.7) Assemble rubber mandrel assembly and install:

K-1.7.1) Install rubber retainer (15), element array (13), and gage ring (29) (if applicable) onto rubber mandrel (11).

K-1.7.2) Install rubber mandrel assembly onto inner mandrel (2).

K-1.7.3) Screw rubber mandrel (11) into center coupling (10).

CAUTION6: Do not rip or tear o-ring during installation.

K-1.8) Screw lower cone (16) into rubber retainer (15).

K-1.9) Assemble drag block body assembly and install:

K-1.9.1) Install lower slips (17) and lower slip springs (25) into drag block body (18). Wedge lower slips (17) outwards.

NOTE10: Install two (2ea) springs per slip (Fig. 6).

K-1.9.2) Install drag block body assembly onto rubber mandrel (11).

K-1.10) Screw rubber mandrel cap (19) onto rubber mandrel (11). Remove wedges.

NOTE7: For added leverage, insert a rod through rubber retainer (15) and rubber mandrel (11) as needed.

K-1.11) Install drag block retainer (21) onto drag block body (18).

K-1.12) Screw J-body (20) onto drag block body (18) (**NOTE5:** Left-hand threads).

K-1.13) Screw set screws (31) into J-body (20).

K-1.14) Install o-ring (32) in o-ring groove in J-pin bottom sub (23).

K-1.15) Screw J-pin bottom sub (23) onto inner mandrel (2).

CAUTION6: Do not rip or tear o-ring during installation.

NOTE4: Drag block body assembly must be free to rotate.



Fig. 5



Fig. 6

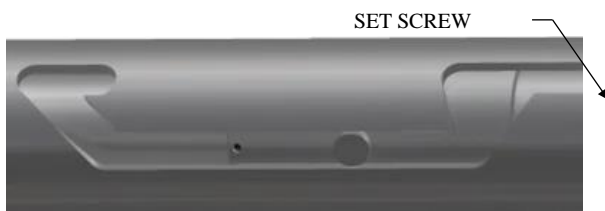

Fig. 7

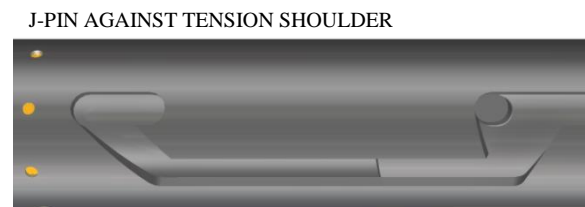

Fig. 8

K-1.16) Move J-body (20) as needed to access threaded holes in J-pin bottom sub (23). Screw set screw (28) into J-pin bottom sub (23) (Fig. 7).

K-1.17) Position J-pin of J-pin bottom sub (23) on tension shoulder in J-slot of J-body (20) (Fig. 8).



VSI-X HT PACKER
w/ HSN ECNER
5-1/2" X 2-7/8"

Manual No:
DL-603-5500-630

Revision: **F**

Revision Date:
08/16/2019

Authored by: J.Anderson

Approved by: B.Oligschlaeger

K) ASSEMBLY (cont'd)

- K-1.18) Align threaded holes in J-body (20) with pocket holes in rubber mandrel cap (19). Wrench on rubber retainer (15) as needed to properly align threaded holes. Screw shear screws (3) into J-body (20). Tighten until shear screws (3) make contact with rubber mandrel cap (19). Back shear screws (3) out 1/4 turn.
- K-1.19) Screw bottom nipple (28) into J-pin bottom sub (23).
- K-1.20) Tighten center coupling (10) onto upper cone (9).
- K-2) Unclamp spring cage (5) from vise and remove assembled tool.



VSI-X HT PACKER
w/ HSN ECNER
5-1/2" X 2-7/8"

Manual No:
DL-603-5500-630

Revision: **F**

Revision Date:
08/16/2019

Authored by: J.Anderson

Approved by: B.Oligschlaeger

L) PARTS LIST

ITEM	QTY	DESCRIPTION	MATERIAL	14.0 – 20.0# P/N 60156HTBHC	20.0 – 23.0# P/N 60159HTBHC	23.0 – 26.0# P/N 60151HTBHC
1	1	TOP SUB	DLMS110	60156610HT		
2	1	INNER MANDREL	DLMS110	60356210HT	60359210HT	60351210HT
3	-	SHEAR SCREW (2375#)	DLM360BRS	-	60100990 (8 EA)	
4	1	COMPRESSION SPRING	DLMCRSP	60356920		
5	1	SPRING CAGE BODY	P-110/1026	60156325HT	60159325HT	60151325
6	8	SHEAR SCREW (2375#)	DLM360BRS	-	90555990	
7	1	RELEASING SLIP	DLMS110	60056125		
8	2	UPPER SLIP W/ CARBIDE	DLMS110	60056115C		
9	1	UPPER CONE	DLMS110	60356410HT		60351410
10	1	CENTER COUPLING	DLMS80	60056620		60051620B
11	1	RUBBER MANDREL	P-110	60056220HTECNER- OLD	60059220HTECNER- OLD	60051220ECNER
12	3	CAP SCREW 1/4-20 UNC X 1/2	STEEL	-	-	SCS025C050 (3EA)
13	1	ECNER ELEMENT ARRAY	80 DURO HSN	OEM55BH	OEM56BH	OEM56BH
14	8	SHEAR SCREW (5500#) 1/2-13 UNC X 7/16 *	DLM360BRS	BSSSLT050C043*		
15	1	RUBBER RETAINER	DLMS60	60256850ECNER	60259850ECNER	60251850B
16	1	LOWER CONE	DLMS110	60056420HT	60059420HT	60051420
17	4	LOWER SLIP W/ CARBIDE	DLMS110	60056135C		
18	1	DRAG BLOCK BODY	DLMS60	60056335	60059335	60051335



VSI-X HT PACKER

w/ HSN ECNER

5-1/2" X 2-7/8"

Manual No:
DL-603-5500-630

Revision: **F**

Revision Date:
08/16/2019

Authored by: J.Anderson

Approved by: B.Oligschlaeger

L) PARTS LIST (cont'd)

ITEM	QTY	DESCRIPTION	MATERIAL	14.0 – 20.0# P/N 60156HTBHC	20.0 – 23.0# P/N 60159HTBHC	23.0 – 26.0# P/N 60151HTBHC
19	1	RUBBER MANDREL CAP	DLMS60	60156230		
20	1	J-BODY	DLMS60	60156340		60151340
21	1	DRAG BLOCK RETAINER	DLMS60	60056910	60059910	60051910
22	1	BOTTOM NIPPLE	DLMS80	60370636		
23	1	J-PIN BOTTOM SUB	DLMS110	60356634HT		60351634
24	1	DUAL PACK SEAL	90 DURO HSN	60056520BH		
25	8	LOWER SLIP SPRING	-	7155901		
26	6	UPPER SLIP SPRING	-	7155902		
27	1	SPRING CAGE CAP	DLMS60	60156810	60159810	60151810
28	2	SET SCREW 1/4-20 UNC	STEEL	SSS025C037 (3/8" LONG)	SSS025C050 (1/2" LONG)	SSS025C037 (3/8" LONG)
29	1	GAGE RING	DLMS60	60256830ECNER	60259830ECNER	-
30	1	BEARING BUSHING	DLMS60	60056224		
31	3	SET SCREW 5/16-18 UNC	STEEL	SSS031C037 (3/8" LONG)	SSS031C031 (5/16" LONG)	
32	1	231 O-RING	90 DURO HSN	90231H		
33	1	235 O-RING	90 DURO HSN	90235H		

* Refer to WLAK tech manual for placement.

REDRESS KIT (RDK)		60156050HTBH	60159050HTBH	60151050HTBH
ASSEMBLED WEIGHT		186 LBS	174 LBS	165 LBS



VSI-X HT PACKER w/ HSN ECNER 5-1/2" X 2-7/8"

Manual No:
DL-603-5500-630

Revision: **F**

Revision Date:
08/16/2019

Authored by: J.Anderson

Approved by: B.Oligschlaeger

M) TECHNICAL ILLUSTRATION

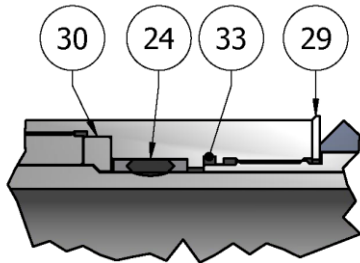

DETAIL A

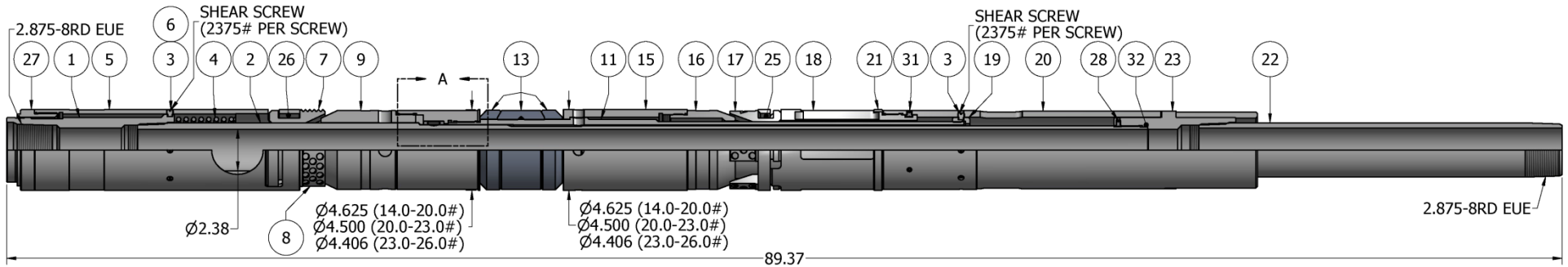

	VSI-X HT PACKER w/ HSN ECNER 5-1/2" X 2-7/8"	Manual No: DL-603-5500-630
		Revision: F
		Revision Date: 08/16/2019
<i>Authored by: J.Anderson</i>		<i>Approved by: B.Oligschlaeger</i>

N) SEAL SURFACES

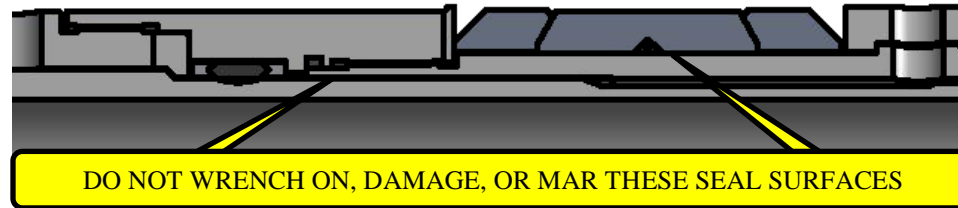

O) REVISION HISTORY

DATE	REVISION	DESCRIPTION OF CHANGES	REVISED BY	APPROVED BY
08/16/2019	F	Revised 60351210HT was 60351210, OEM56BH was OEM54BH	J.Anderson	K.Plunkett
05/18/2018	E	Added Caution7; Revised Elastomer Trim Temp. Guide nitrile temp rating	J.Anderson	J.Johnson
07/01/2016	D	Removed tool drift ID; Added General Screw Torque Recommendations; Revised P/N OEM54BH was OEM56BH for tool P/N 60151HTBHC	J.Anderson	N.Banker
04/22/2015	C	Added – RELATED TOOLS, SPECIFICATION GUIDE - P/N's and Data (P/N 60156HTBHC, P/N 60159HTBHC), Drift ID, Pre-Installation Inspection Procedures, Caution2, Storage Procedures, Note8, Fig. 2 - 7, Note12, Caution5, Elastomer Trim Options Parts List to Parts List, Technical Illustration – Gage OD's, SEAL SURFACES Section; Revised – Removed HSN from Title, Description, WLAK was 5-7/8", PRESSURE AFFECTED AREA GUIDE – Updated inches2 values, ELASTOMER TRIM TEMPERATURE GUIDE was ELEMENT SELECTION GUIDE and removed AFLAS, Note9, Caution5, Material was P-110 (P/N 60351210), Material was blank (P/N OEM56BH) , 60056520BH, 90231H, 90235H), Technical Illustration – Detail A; Removed – Note1 & Note3 (info was put in RELATED TOOLS), P/N 60151HTBAC (AFLAS), Removed 1AFLAS;	B.Mathis	T.Myerly
01/16/14	B	Revised assembly instructions (H-1.7 and H-1.21), P/N 60051220ECNER was P/N 60051220B;	J.Anderson	B.Oligschlaeger
10/31/13	A	Created new tech manual;	-	-