



VSI-X HT PACKER, CARBIDE WITH DOUBLE HOOK J-SLOT 5-1/2" X 2-3/8"

Manual No:
DL-601-5500-760

Revision: **C**

Revision Date:
05/06/2020

Authored by : J.Anderson

Approved by: T.Myerley

A) DESCRIPTION

The VSI-X Single String Double-Grip Production Packer is one of the most versatile packers on the market. This packer is a modification of the ASI-X Packer with the advantage of being able to set on electric line or hydraulically.

An On-Off Tool Stinger with a Wireline Plug installed can be attached to the top of this packer. This packer can then be lubricated in the hole and set under pressure. Once set, casing pressure can be bled off, and the tubing with an On-Off Tool Overshot can be run and latched onto the packer. The Wireline Plug can then be removed.

This packer easily converts to a mechanically set ASI-X Packer – just remove the shear screws and install drag blocks and drag block springs. The ASI-X Packer sets with 1/4 right-hand rotation and releases with 1/4 right-hand rotation. The ASI-X Packer can be left in tension, compression or neutral.

This packer features a double hook J-slot to prevent the packer from unsetting when manipulating the work string above the packer in tension.

NOTE₁: Stinger and Wireline Adapter Kit (WLAK) sold separately.

NOTE₂: This packer requires at least a 30 second burn on the wireline setting tool to ensure a proper set. A burn time less than 30 seconds may shear the setting tool off of the packer before fully setting the packer.

CAUTION₁: Do not run the tool without properly tightening connections. Running the tool with loose connections may damage the tool and cause malfunction.

B) RELATED TOOLS (sold separately)

B-1) 5-1/2 X 2-3/8" Wireline Adapter Kit (WLAK) (P/N 97155)—refer to technical manual *DL-971-5500-754*.

B-2) 2-3/8" DT-2 On/Off Tool (P/N varies)—refer to technical manual *DL-512-2375-360*.

B-3) 2-3/8" Stinger—P/N varies depending on customer requirements.

C) SPECIFICATION GUIDE

CASING			TOOL		THREAD CONNECTION BOX UP / PIN DOWN	PART NUMBER
SIZE (INCHES)	WEIGHT (LBS/FT)	RECOMMENDED HOLE SIZE (INCHES)	OD (INCHES)	ID (INCHES)		
5-1/2	14.0 - 20.0	4.778 - 5.012	4.625	2.00	2-3/8 EUE	60155HTDJC 60155HTDJCH ¹ 60155HTDJCV ²
	20.0 - 23.0	4.670 - 4.778	4.500	2.00	2-3/8 EUE	60157HTDJC 60157HTDJCH ¹ 60157HTDJCV ²

Elastomer Trim Options: ¹HSN, ²Viton

NOTE₃: Tools listed are right-hand set / right-hand release.

DIFFERENTIAL PRESSURE (MAX)	TENSILE LOAD THRU TOOL (MAX)
10,000 PSI	75,000 LBS

D & L OIL TOOLS
P.O. BOX 52220 TULSA, OK 74152
PHONE: (800) 441-3504 www.dloiltools.com



VSI-X HT PACKER, CARBIDE WITH DOUBLE HOOK J-SLOT 5-1/2" X 2-3/8"

Manual No:
DL-601-5500-760

Revision: **C**

Revision Date:
05/06/2020

Authored by : J.Anderson

Approved by: T.Myerley

D) PRE-INSTALLATION INSPECTION PROCEDURES

CAUTION₂: D&L ships tool connections made-up **HAND TIGHT**—labeled with hand-tight tape on the tool (Fig. 1)—unless stated otherwise. Tighten/torque all connections properly before operating tool.



Fig. 1

GENERAL THREAD CONNECTION TORQUE RECOMMENDATIONS			
STUB ACME / ACME THREADS	INTERNAL TAPERED TUBING THREADS		PREMIUM THREADS
	UP TO 2-3/8"	GREATER THAN 2-3/8"	
600 – 800 FT-LBS	600 – 800 FT-LBS	800 – 1,200 FT-LBS	Consult thread manufacturer's recommendations.

GENERAL SCREW TORQUE RECOMMENDATIONS									
SCREW SIZE (INCHES)	#6	#8	#10	1/4	5/16	3/8	7/16	1/2	5/8 and larger
TORQUE RANGE (INCH-POUNDS)	5 – 8	10 – 15	18 – 25	25 – 40	50 – 80	90 – 135	160 – 210	250 – 330	450 - 650

Before first use, D&L recommends disassembly and inspection of the tools unless stated otherwise. Ensure parts have not been damaged during shipping. Replace damaged parts with D&L replacement parts. Contact D&L sales for replacement part information.

Re-assemble the tool after inspection. Install parts in the correct order and orientation. Properly tighten connections.

Before re-using the tool, D&L recommends disassembly and inspection of the tool. Clean parts and ensure parts are in good working condition. Replace worn or damaged parts with D&L replacement parts.

When redressing the tool, D&L recommends replacement of all seals, elements, o-rings, shear screws, etc. Contact D&L sales for redress kit and/or other part information.

E) RELEASING PROCEDURES

Set down weight on the packer and rotate the tubing 1/4 turn to the right at the packer and pick up while holding right-hand torque. Weight in addition to pipe weight may be required to pick up on packer - refer to Pressure Affected Area Guide. The internal by-pass will open, allowing pressure to equalize. After pressure is equalized, continue to pick up to release the upper slips, relax the elements and release the lower slips.

CAUTION₃: High differential pressure below the VSI-X HT Packer may cause the upper slips to wedge in tighter, requiring an extra amount of tension to release the upper slips.

F) STORAGE RECOMMENDATIONS

When preparing the tool for storage, follow the Pre-Installation Inspection Procedures. Re-assemble the tool with connections hand-tight only and in running position if applicable. Elements should be in a relaxed state—free from tension, compression, and other stresses that could cause deformation.

Store the tool, if possible, in an enclosed, temperature and humidity controlled environment. Avoid excessively high temperatures over long periods of time. Shield elastomeric parts from ultraviolet light sources. Keep tool dry and protected from condensation. Do not store in contact with or near volatile or corrosive chemicals. Do not store near ozone generating equipment or operations such as welding.



VSI-X HT PACKER, CARBIDE WITH DOUBLE HOOK J-SLOT 5-1/2" X 2-3/8"

Manual No:
DL-601-5500-760

Revision: **C**

Revision Date:
05/06/2020

Authored by : J.Anderson

Approved by: T.Myerley

G) PRESSURE AFFECTED AREA GUIDE

PACKER SIZE (INCHES)	TUBING SIZE (INCHES)	PRESSURE AFFECTED AREA (SQ. INCHES)	
		ABOVE	BELOW
5-1/2	2.375	0.92 (DOWN)	-2.22 (UP)
	2.875	-1.15 (UP)	-0.67 (UP)

Example: Consider a 5-1/2" X 2-3/8" VSI-X Packer set on 2.375" tubing with a differential pressure of 3,000 PSI in the annulus around the tubing above the packer. What is the force acting on the seal area of the mandrel?

To calculate the force (lbs) acting on the seal area of the mandrel, refer to the Pressure Affected Area Guide for a 5-1/2" X 2-3/8" VSI-X Packer run on 2.375" tubing. In this example, the differential pressure from above the packer acts on the seal area of the packer mandrel across a pressure affected area of 0.92 in². Multiplying the differential pressure (3,000 PSI) by the pressure affected area (0.92 in²) results in a force of 2,760 lbs. The piston effect on the packer mandrel is a downward force of 2,760 lbs.

H) ELASTOMER TRIM TEMPERATURE

NITRILE (STD)			
TEMPERATURE RANGE (F°)	DUROMETER		
	END	MIDDLE	END
40° - 125°	80	70	80
125° - 250°	90	70	90
150° - 250°	90	80	90
250° +	Contact D&L Sales		

RUBBER TYPE	TEMPERATURE RANGE
NITRILE	40° - 250°F
HSN (HNBR)	70° - 300°F
VITON	100° - 350°F

I) RECOMMENDED TOOLS

I-1) HAND TOOLS

- VISE
- GLOVES
- ALLEN WRENCHES
- TAPE MEASURE
- O-RING PICK
- BAR
 - 1/2-INCH
 - 3/4-INCH
- PAINT BRUSH, 2-INCH
- PIPE WRENCH, 3-FT (2 EA)
- "CHEATER" PIPE, 4-FT LONG
- ADJUSTABLE WRENCH, 12-INCH
- CORDLESS DRILL, 18V
- SNAP RING SPREADER PLIERS
- ALIGNING PUNCH
- SCREWDRIVER SET, FLAT-TIPPED
- SOCKET SETS
 - 3/8-INCH DRIVE
 - 1/2-INCH DRIVE
- HAMMERS
 - SLEDGE
 - BALL PEEN
 - DEAD BLOW

I-2) SPECIAL TOOLS

ITEM	QTY	DESCRIPTION	PART NUMBER
T-1	1	ASSEMBLY TOOL 4-1/2" - 7-5/8" VSI-XW	AT100



VSI-X HT PACKER, CARBIDE WITH DOUBLE HOOK J-SLOT 5-1/2" X 2-3/8"

Manual No:
DL-601-5500-760

Revision: **C**

Revision Date:
05/06/2020

Authored by : J.Anderson

Approved by: T.Myerley

J) DISASSEMBLY

J-1) Clamp spring cage (5) in vise.

J-1.1) Unscrew and remove shear screws (3) from J-body (20).

J-1.2) Unscrew and remove bottom nipple (28) from J-pin bottom sub (23).

J-1.3) Unscrew and remove set screws (22) from J-pin bottom sub (23). Move J-body (20) as needed to access set screws (22).

J-1.4) Unscrew and remove J-pin bottom sub (23) from inner mandrel (2).

NOTE4: Drag block body assembly must be free to rotate.

J-1.4.1) Remove o-ring (32) from J-pin bottom sub (23).

J-1.5) Unscrew and remove shear screws (3) from J-body (20).

J-1.6) Unscrew and remove set screws (30) from J-body (20).

J-1.7) Unscrew and remove J-body (20) from drag block body (18) (**NOTE5:** Left-hand threads).

J-1.8) Remove drag block retainer (21) from drag block body (18).

J-1.9) Unscrew and remove rubber mandrel cap (19) from rubber mandrel (11).

NOTE6: For added leverage, insert a rod through rubber retainer (15) and rubber mandrel (11) as needed.

J-1.10) Wedge lower slips (17) outwards (if needed). Remove drag block body assembly and disassemble:

J-1.10.1) Remove wedges (if needed). Remove lower slips (17) and lower slip springs (25) from drag block body (18).

J-1.11) Unscrew and remove lower cone (16) from rubber retainer (15).

J-1.12) Unscrew rubber mandrel (11) from center coupling (10).

J-1.13) Remove rubber mandrel assembly and disassemble:

J-1.13.1) Remove gage ring (29), elements (13, 14), rubber spacers (12), and rubber retainer (15) from rubber mandrel (11).

J-1.14) Unscrew and remove center coupling (10) from upper cone (9).

J-1.14.1) Remove bonded seal (24) and o-ring (33) from center coupling (10).

J-1.14.1.1) Remove o-ring (31) from bonded seal (24).

J-1.15) Remove upper cone (9) from inner mandrel (2).

J-1.16) Wedge slips outwards (if needed). Unscrew and remove inner mandrel (2) from top sub (1).

J-1.17) Remove wedges (if needed). Remove releasing slip (7), upper slips (8) and upper slip springs (26) from upper slip body (6).

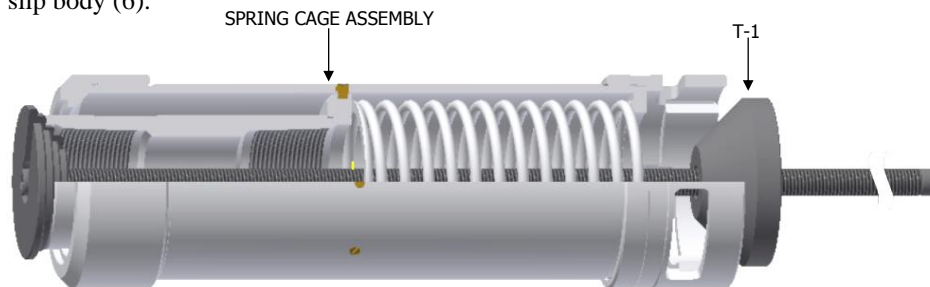

Fig. 2

J-1.18) Disassemble spring cage assembly:

J-1.18.1) Position assembly tool (T-1) hand-tight against top sub (1) and upper slip body (6) of spring cage assembly (Fig. 2).

CAUTIONS: Compression spring (4) is compressed with tension against spring cage assembly.



VSI-X HT PACKER, CARBIDE WITH DOUBLE HOOK J-SLOT 5-1/2" X 2-3/8"

Manual No:
DL-601-5500-760

Revision: **C**

Revision Date:
05/06/2020

Authored by : J.Anderson

Approved by: T.Myerley

J) DISASSEMBLY (cont'd)

- J-1.18.2) Unscrew and remove shear screws (3) from spring cage (5).
- J-1.18.3) Release compression spring (4) tension by loosening assembly tool (T-1) until enough space exists between stepped cone of assembly tool (5) and spring cage cap (27) for spring cage cap (27) to be unscrewed from spring cage (5).
- J-1.18.4) Unscrew spring cage cap (27) from spring cage (5).
- J-1.18.5) Release remaining compression spring (4) tension by loosening assembly tool (T-1). Remove tool from assembly.
- J-1.18.6) Remove spring cage cap (27), top sub (1), and compression spring (4) from spring cage (5).
- J-1.18.7) Unscrew and remove upper slip body (6) from spring cage (5).

J-2) Unclamp and remove spring cage (5) from vise.

K) ASSEMBLY

NOTE7: Clean and inspect all parts. Replace all worn and damaged parts. Install parts in proper order, and orientation and tighten/torque all connections properly.

CAUTION4: To ensure tool operates properly, install o-rings in o-ring grooves **NOT** thread reliefs (Fig. 3).

K-1) Clamp spring cage (5) in vise.

K-1.1) Assemble spring cage assembly:

- K-1.1.1) Screw upper slip body (6) onto spring cage (5).
- K-1.1.2) Install compression spring (4) and top sub (1) into spring cage (5).
- K-1.1.3) Screw spring cage cap (27) onto spring cage (5).

NOTE9: Press down top sub (1) to compress compression spring (4) as necessary.

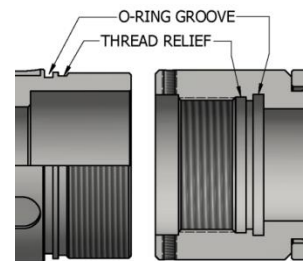

Fig. 3

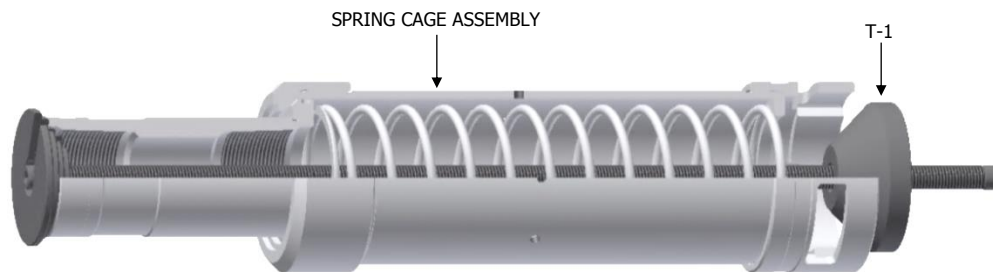

Fig. 4

- K-1.1.4) Compress compression spring (4) with assembly tool (T-1) (Fig. 4).
- K-1.1.5) Align threaded holes in spring cage (5) with recessed holes in top sub (1). Screw shear screws (3) into spring cage (5). Tighten until shear screws (3) make contact with top sub (1). Back shear screws (3) out 1/4 turn.
- K-1.1.6) Remove assembly tool (T-1) from spring cage assembly.
CAUTION5: Compression spring (4) is compressed with tension against spring cage assembly.
- K-1.1.7) Install upper slips (8), releasing slip (7) and upper slip springs (26) into upper slip body (6). Wedge releasing slip (7) and upper slips (8) outwards.

NOTE8: Install two (2ea) springs per slip (Fig. 5).

K-1.2) Screw inner mandrel (2) into top sub (1). Remove wedges.

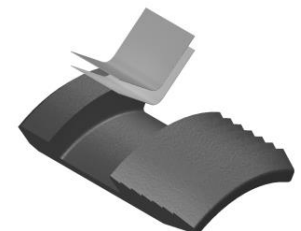

Fig. 5



VSI-X HT PACKER, CARBIDE WITH DOUBLE HOOK J-SLOT 5-1/2" X 2-3/8"

Manual No:
DL-601-5500-760

Revision: **C**

Revision Date:
05/06/2020

Authored by : J.Anderson

Approved by: T.Myerley

K) ASSEMBLY (cont'd)

K-1.3) Install upper cone (9) onto inner mandrel (2).

K-1.4) Install o-ring (31) into groove in bonded seal (24).

K-1.5) Install bonded seal (24) into center coupling (10).

CAUTION6: Do not rip or tear o-ring during installation.

K-1.6) Install o-ring (33) in groove in center coupling (10).

K-1.7) Screw center coupling (10) onto upper cone (9).

K-1.8) Assemble rubber mandrel assembly and install:

K-1.8.1) Install rubber retainer (15), elements (13, 14), rubber spacers (12), and gage ring (29) onto rubber mandrel (11).

K-1.8.2) Install rubber mandrel assembly onto inner mandrel (2) and screw rubber mandrel (11) into center coupling (10).

CAUTION6: Do not rip or tear o-ring during installation.

K-1.9) Screw lower cone (16) into rubber retainer (15).

K-1.10) Assemble drag block body assembly and install:

K-1.10.1) Install lower slips (17) and lower slip springs (25) into drag block body (18). Wedge lower slips (17) outwards.

NOTE8: Install two (2ea) springs per slip (Fig. 6).

K-1.10.2) Install drag block body assembly onto rubber mandrel (11). Remove wedges.

K-1.11) Screw rubber mandrel cap (19) onto rubber mandrel (11).

NOTE6: For added leverage, insert a rod through rubber retainer (15) and rubber mandrel (11) as needed.

K-1.12) Install drag block retainer (21) onto drag block body (18).

K-1.13) Screw J-body (20) onto drag block body (18) (**NOTE5:** Left-hand threads).

K-1.14) Screw set screws (30) into J-body (20).

K-1.15) Install o-ring (32) into groove in J-pin bottom sub (23).

K-1.16) Screw J-pin bottom sub (23) onto inner mandrel (2).

CAUTION6: Do not rip or tear o-ring during installation.

NOTE4: Drag block body assembly must be free to rotate.

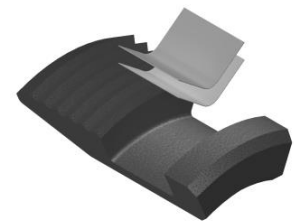

Fig. 6

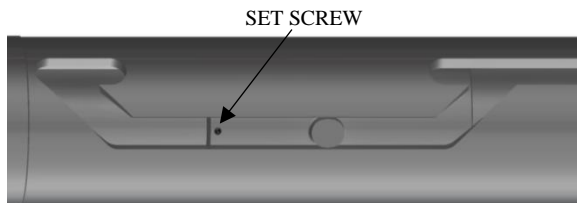

Fig. 7



Fig. 8

K-1.17) Rotate J-body (20) as needed to position J-pin of J-pin bottom sub (23) along J-slot to access threaded holes (Fig. 7). Screw set screws (22) into J-pin bottom sub (23).

K-1.18) Screw bottom nipple (28) into J-pin bottom sub (23).

K-1.19) Position J-pin of J-pin bottom sub (23) in set position in J-slot of J-body (20) (Fig. 8).

K-1.20) Align threaded holes in J-body (20) with pocket holes in rubber mandrel cap (19). Screw shear screws (3) into J-body (20). Tighten until shear screws (3) make contact with rubber mandrel cap (19). Back shear screws (3) out 1/4 turn.

K-2) Unclamp spring cage (5) from vise and remove assembled tool.



VSI-X HT PACKER, CARBIDE WITH DOUBLE HOOK J-SLOT 5-1/2" X 2-3/8"

Manual No:
DL-601-5500-760

Revision: **C**

Revision Date:
05/06/2020

Authored by : J.Anderson

Approved by: T.Myerley

L) PARTS LIST

ITEM	QTY	DESCRIPTION	MATERIAL	14.0 – 20.0#	20.0 – 23.0#
				P/N 60155HTDJC	P/N 60157HTDJC
1	1	TOP SUB	DLMS110	60155610HT	
2	1	INNER MANDREL	DLMS110	60355210HT	60357210HT
3	16	SHEAR SCREW (2375#)	DLM360BRS	60100990	
4	1	COMPRESSION SPRING	DLMCRSP	60355920	
5	1	SPRING CAGE	DLMS60	60155310	
6	1	UPPER SLIP BODY	DLMS110 / DLMS60	60055320HT	
7	1	RELEASING SLIP	DLMS110	60055125	
8	2	UPPER SLIP W/CARBIDE	DLMS110	60055115C	
9	1	UPPER CONE	DLMS110	60355410HT	
10	1	CENTER COUPLING	DLMS80	60355620	
11	1	RUBBER MANDREL	DLMS110	60055220HT	60057220HT
12	2	RUBBER SPACER	DLMS60	60255840	60257840
13	1	ELEMENT	80 DURO NITRILE	60255512	60257512
14	2	ELEMENT	90 DURO NITRILE	60255513	60257513
15	1	RUBBER RETAINER	DLMS80	60255850	60257850
16	1	LOWER CONE	DLMS110	60055420HT	
17	4	LOWER SLIP W/CARBIDE	DLMS110	60055135C	
18	1	DRAG BLOCK BODY	DLMS60 / DLMS35	60055335	60057335
19	1	RUBBER MANDREL CAP	DLMS60	60155230	
20	1	J-BODY	DLMS80	60155345	
21	1	DRAG BLOCK RETAINER	DLMS60	60055910	60057910
22	2	SET SCREW 1/4-20 UNC	STEEL	SSS025C050 (1/2" LONG)	SSS025C043 (1/4" LONG)
23	1	J-PIN BOTTOM SUB	DLMS110	60355634HT	
24	1	BONDED SEAL	90 DURO NITRILE	60055520	
25	8	LOWER SLIP SPRING	-	7155901	
26	6	UPPER SLIP SPRING	-	7155902	
27	1	SPRING CAGE CAP	DLMS60	60155810	60157810
28	1	BOTTOM NIPPLE	DLMS80	60355636	
29	1	GAGE RING	DLMS60	60255830	60257830
30	4	SET SCREW 5/16-18 UNC X 1/2	STEEL	SSS031C050	
31	1	149 O-RING	90 DURO NITRILE	90149	



VSI-X HT PACKER, CARBIDE WITH DOUBLE HOOK J-SLOT 5-1/2" X 2-3/8"

Manual No:
DL-601-5500-760

Revision: **C**

Revision Date:
05/06/2020

Authored by : J.Anderson

Approved by: T.Myerley

L) PARTS LIST (cont'd)

ITEM	QTY	DESCRIPTION	MATERIAL	14.0 – 20.0# P/N 60155HTDJC	20.0 – 23.0# P/N 60157HTDJC
32	1	228 O-RING	90 DURO NITRILE	90228	
33	1	234 O-RING	90 DURO NITRILE	90234	
34	8	SHEAR SCREW (5000#) 7/16-20 UNF X 7/16	DLM360BRS	BSSSLT043F043*	

*Refer to WLAK tech manual for placement.

REDRESS KIT (RDK)		60155050HT	60157050HT
ASSEMBLED WEIGHT		194 LBS	189 LBS

L-1) ELASTOMER TRIM OPTIONS

NOTE₁₀: For temperature range, refer to Elastomer Trim Temperature Guide.

L-1.1) HSN

ITEM	QTY	DESCRIPTION	MATERIAL	14.0 – 20.0# P/N 60155HTDJHC	20.0 – 23.0# P/N 60157HTDJHC
13	1	ELEMENT	80 DURO HSN	60255512H	60257512H
14	2	ELEMENT	90 DURO HSN	60255513H	60257513H
24	1	BONDED SEAL	90 DURO HSN	60055520H	
31	1	149 O-RING	90 DURO HSN	90149H	
32	1	228 O-RING	90 DURO HSN	90228H	
33	1	234 O-RING	90 DURO HSN	90234H	

REDRESS KIT (RDK)		60155050HTH	60157050HTH
-------------------	--	-------------	-------------

L-1.2) VITON

ITEM	QTY	DESCRIPTION	MATERIAL	14.0 – 20.0# P/N 60155HTDJVC	20.0 – 23.0# P/N 60157HTDJVC
13	1	ELEMENT	80 DURO VITON	60255512V	60257512V
14	2	ELEMENT	90 DURO VITON	60255513V	60257513V
24	1	BONDED SEAL	90 DURO VITON	60055520V	
31	1	149 O-RING	90 DURO VITON	90149V	
32	1	228 O-RING	90 DURO VITON	90228V	
33	1	234 O-RING	90 DURO VITON	90234V	

REDRESS KIT (RDK)		60155050HTV	60157050HTV
-------------------	--	-------------	-------------



VSI-X HT PACKER, CARBIDE WITH DOUBLE HOOK J-SLOT 5-1/2" X 2-3/8"

Manual No:
DL-601-5500-760

Revision: **C**

Revision Date:
05/06/2020

Authored by : J.Anderson

Approved by: T.Myerley

M) TECHNICAL ILLUSTRATION

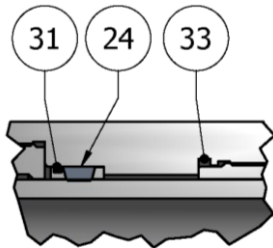

DETAIL A

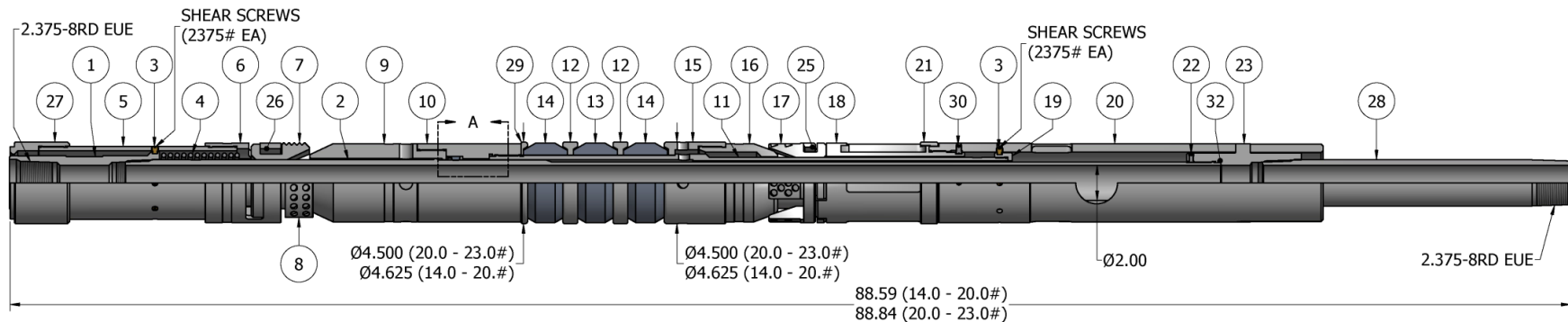

	VSI-X HT PACKER, CARBIDE WITH DOUBLE HOOK J-SLOT 5-1/2" X 2-3/8"	Manual No: DL-601-5500-760
		Revision: C
		Revision Date: 05/06/2020
<i>Authored by : J.Anderson</i>		<i>Approved by: T.Myerley</i>

N) REVISION HISTORY

DATE	REVISION	DESCRIPTION OF CHANGES	REVISED BY	APPROVED BY
05/06/2020	C	Revised 90324 was 90325	J.Anderson	J.Johnson
04/26/2019	B	Removed drift ID; Revised Elastomer Trim Temperature Guide temp. ratings; Added General Screw Torque Recommendations; Revised P/N BSSSLT043F043 shear value was 4,300 lbs	J.Anderson	J.Johnson
10/29/14	A	Created new manual	-	-